



Check Valves (C Series)

Catalog 4130-C
August 2005



Introduction

Parker C Series Check Valves are designed for uni-directional flow control of fluids and gases in industries such as chemical processing, oil and gas production and transmission, pharmaceutical, pulp and paper, power and utilities.

Features

- ▶ Resilient, custom molded, blow-out resistant seat design
- ▶ Back stopped poppet minimizes spring stress
- ▶ 100% factory tested for both crack and reseal
- ▶ Cracking pressures include: 1/3, 1, 5, 10, 25, 50, 75, and 100 psi.
- ▶ Port connections include male and female NPT, CPI™, A-LOK®, UltraSeal, VacuSeal, BSP, SAE and Seal-Lok®
- ▶ Heat code traceability

Materials of Construction

Item #	Part	Stainless Steel Valve	Brass Valve
1	Cap	ASTM A 276, TYPE 316	ASTM B 16 Alloy C36000
2	Seat*	Fluorocarbon Rubber*	
3	Poppet	ASTM A 479, TYPE 316	ASTM B 16 Alloy C36000
4	Spring	316 Stainless Steel	
5	Body	ASTM A 276, TYPE 316	ASTM B 16 Alloy C36000

* Optional seat materials are available. See How to Order section. Lubrication: Silicone Paste.

Note: PTFE seated valves employ an additional PTFE coated 316 SS gasket between the seat and the body and are distinguishable from elastomeric seated valves by the gap designed between the body and cap.

**See Pressure Rating note on page 4.

Specifications

Pressure Rating:**

316 SS – 1/8" to 3/4":6000 psig (414 bar) CWP
 1":5000 psig (345 bar) CWP
 All sizes with PTFE Seats:4000 psig (276 bar) CWP
 Brass – 1/8": to 1":3000 psig (207 bar) CWP

Temperature Rating:

Fluorocarbon Rubber..... -15°F to +400°F (-26°C to +204°C)
 Nitrile -30°F to +275°F (-34°C to +135°C)
 Ethylene Propylene Rubber
 -70°F to +275°F (-57°C to +135°C)
 Neoprene Rubber -45°F to +250°F (-43°C to +121°C)
 PTFE -65°F to +400°F (-54°C to +204°C)
 Highly Fluorinated Fluorocarbon Rubber
 -15°F to +200°F (-26°C to +93°C)

Orifice:..... .078" to .656" (2.0 mm to 16.7 mm)
C_v: 18 to 6.56

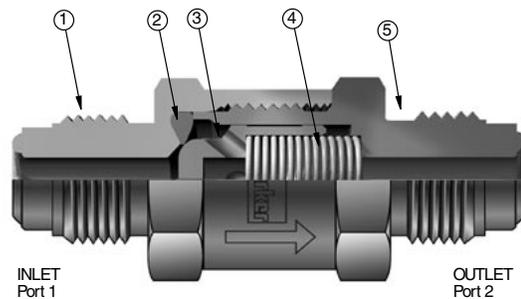

Model Shown: 4V-C4L-5-SS

Flow Calculations with 1000 psig (69 bar) Inlet Pressure

Valve Series	Maximum C _v	Pressure Drop ΔP		Water @ 60°F (16°C)		Air @ 60°F (16°C)	
		psig	bar	gpm	m ³ /hr	scfm	m ³ /hr
C2	0.31	10	0.7	1.0	0.2	30.8	52.1
		50	3.4	2.2	0.5	67.2	112.8
		100	6.9	3.1	0.7	92.0	155.3
C4	0.75	10	0.7	2.4	0.5	74.6	126.1
		50	3.4	5.3	1.2	162.7	273.0
		100	6.9	7.5	1.7	222.8	376.2
C6	2.26	10	0.7	7.1	1.6	225.3	380.9
		50	3.4	16.0	3.6	495.2	831.0
		100	6.9	22.6	5.1	685.1	1157.2
C8	3.53	10	0.7	11.2	2.5	352.0	595.0
		50	3.4	25.0	5.6	774.3	1299.4
		100	6.9	35.3	8.0	1072.4	1811.6
C12	6.01	10	0.7	19.0	4.3	596.6	1008.3
		50	3.4	42.5	9.6	1287.5	2160.4
		100	6.9	60.1	13.7	1738.5	2934.5
C16	6.56	10	0.7	20.7	4.7	648.9	1096.6
		50	3.4	46.4	10.5	1379.4	2314.7
		100	6.9	65.6	14.9	1824.4	3077.6

Crack and Re-seal Performance

Check Valve Rated Crack Pressure		Minimum Acceptable Crack Pressure		Maximum Acceptable Crack Pressure		Maximum Re-seal Back Pressure	
psig	bar	psig	bar	psig	bar	psig	bar
1/3	0.02	0	0.00	1	0.07	4	0.28
1	0.07	0	0.00	3	0.21	4	0.28
5	0.34	3	0.21	8	0.55	3 BCP	0.21 BCP
10	0.69	7	0.48	13	0.90	3 BCP	0.21 BCP
25	1.72	20	1.38	30	2.07	4 BCP	0.28 BCP
50	3.45	40	2.76	60	4.14	5 BCP	0.34 BCP
75	5.17	60	4.14	90	6.21	7 BCP	0.48 BCP
100	6.89	80	5.52	120	8.27	10 BCP	0.69 BCP

BCP means "Below Cracking Pressure"

Cracking pressure is defined as the upstream pressure at which a detectable flow is measured.

Re-seal pressure is defined as the downstream pressure at which the check valve closes bubble-tight.

Example: For a valve with a spring having a rated cracking pressure of 25 psig (1.72 bar), the actual cracking pressure ranges between 20 and 30 psig (1.38 and 2.07 bar). The re-seal pressure range would be 16 to 20 psig (1.10 to 1.38 bar). Check valves having springs with rated crack pressures of 3 psig (0.21 bar) or less may require up to 4 psig (0.28 bar) back pressure to re-seal bubble-tight.

Note: Check valves which are not actuated for a period of time may initially crack at higher than the above crack pressure ranges. PTFE seated valves require a minimum back pressure of 100 psig (6.9 bar) to insure a leak-tight re-seal.

Pressure vs. Temperature

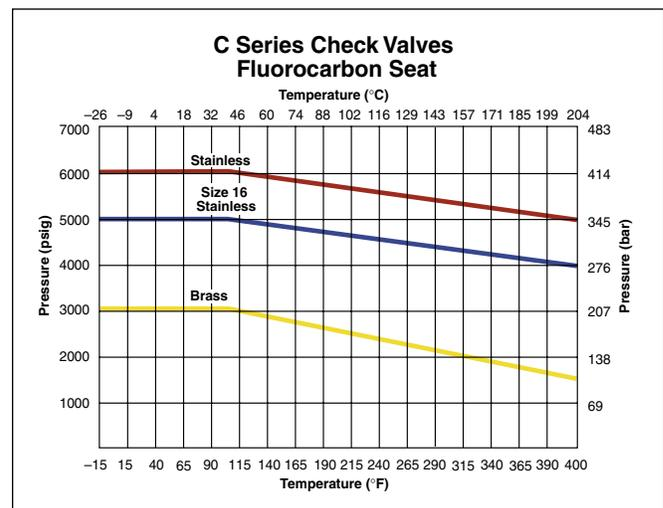
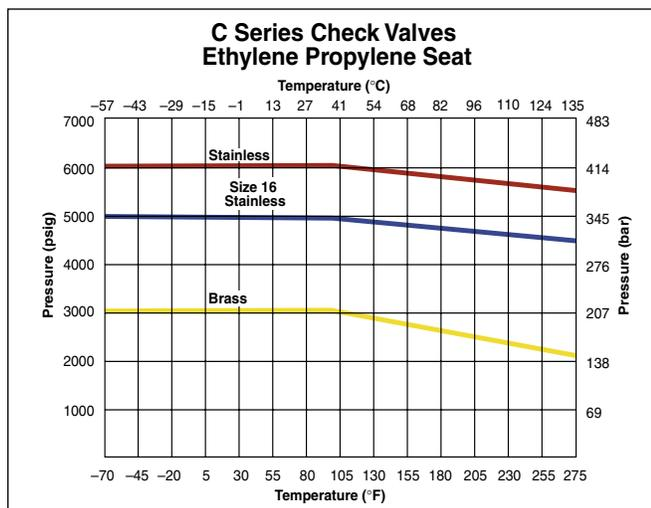
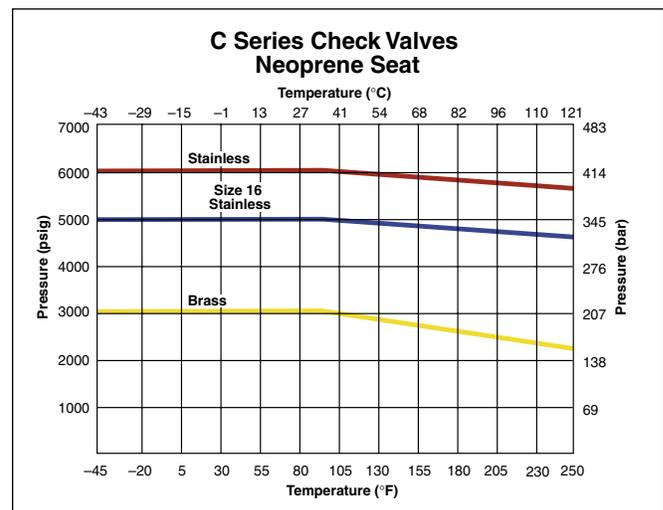
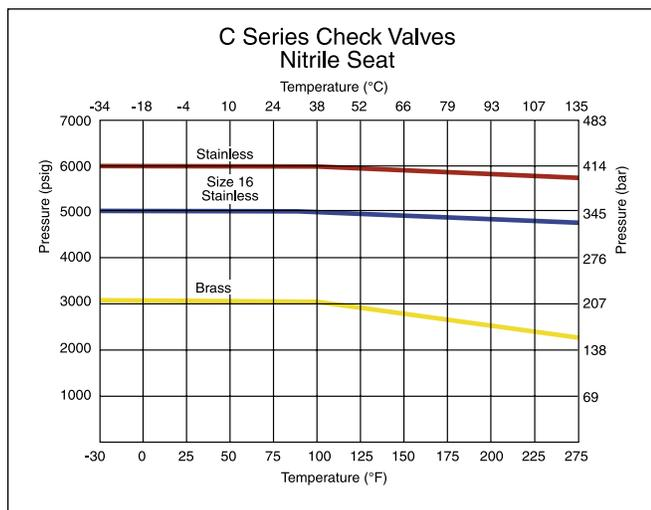

Note: To determine MPa, multiply bar by 0.1

Flow Data/Dimensions

Basic Part Number	End Connections		Flow Data				Dimensions							
	(Inlet) Port 1	(Outlet) Port 2	Orifice		C _v	K _t †	A†		B		C		D	
			inch	mm			inch	mm	inch	mm	inch	mm		
2A-C2L	1/8" A-LOK® Compression	1/8" A-LOK® Compression	.093	2.4	.22	0.46	2.29	58.2	1.09	27.7	.625	15.9	.438	11.1
2F-C2L	1/8" Female NPT	1/8" Female NPT	.125	3.2	.31	0.52	1.86	47.2	-	-	.625	15.9	-	-
2F5-C2L	1/8" Male SAE	1/8" Male SAE	.063	1.6	.16	0.42	1.69	42.9	1.09	27.7	.625	15.9	-	-
2G5-C2L	1/8" Female SAE	1/8" Female SAE	.063	1.6	.16	0.42	1.86	47.2	-	-	.625	15.9	-	-
2KF-C2L	1/8" Female BSP/ISO Tapered	1/8" Female BSP/ISO Tapered	.125	3.2	.31	0.52	1.86	47.2	-	-	.625	15.9	-	-
2KM-C2L	1/8" Male BSP/ISO Tapered	1/8" Male BSP/ISO Tapered	.125	3.2	.31	0.52	1.77	45.0	1.00	25.4	.625	15.9	-	-
2M-C2L	1/8" Male NPT	1/8" Male NPT	.125	3.2	.31	0.52	1.77	45.0	1.01	25.7	.625	15.9	-	-
2TA-C2L	1/8" Tube Adapter	1/8" Tube Adapter	.078	2.0	.18	0.43	2.07	52.6	.88	22.4	.625	15.9	-	-
2Z-C2L	1/8" CPI™ Compression	1/8" CPI™ Compression	.093	2.4	.22	0.46	2.29	58.2	1.09	27.7	.625	15.9	.438	11.1
M3A-C2L	3mm A-LOK® Compression	3mm A-LOK® Compression	.086	2.2	.20	0.45	2.30	58.4	1.05	26.7	.625	15.9	.472	12.0
M3Z-C2L	3mm CPI™ Compression	3mm CPI™ Compression	.086	2.2	.20	0.45	2.30	58.4	1.05	26.7	.625	15.9	.472	12.0
2M2A-C2L	1/8" Male NPT	1/8" A-LOK® Compression	.093	2.4	.22	0.46	2.03	51.6	1.05	26.7	.625	15.9	.438	11.1
2M2F-C2L	1/8" Male NPT	1/8" Female NPT	.125	3.2	.31	0.52	1.81	46.0	1.43	36.3	.625	15.9	-	-
2M2Z-C2L	1/8" Male NPT	1/8" CPI™ Compression	.093	2.4	.22	0.46	2.03	51.6	1.05	26.7	.625	15.9	.438	11.1
2F-C4L	1/8" Female NPT	1/8" Female NPT	.187	4.7	.75	0.53	2.01	51.1	-	-	.750	19.1	-	-
2M-C4L	1/8" Male NPT	1/8" Male NPT	.187	4.7	.75	0.53	1.82	46.2	1.06	26.9	.750	19.1	-	-
4A-C4L	1/4" A-LOK® Compression	1/4" A-LOK® Compression	.187	4.7	.75	0.53	2.42	61.5	1.03	26.2	.750	19.1	.563	14.3
4F-C4L	1/4" Female NPT	1/4" Female NPT	.187	4.7	.75	0.53	2.40	61.0	-	-	.750	19.1	-	-
4F5-C4L	1/4" Male SAE	1/4" Male SAE	.172	4.4	.66	0.52	2.02	51.3	1.15	29.2	.750	19.1	-	-
4G5-C4L	1/4" Female SAE	1/4" Female SAE	.172	4.4	.66	0.52	2.20	55.9	-	-	.750	19.1	-	-
4KF-C4L	1/4" Female BSP/ISO Tapered	1/4" Female BSP/ISO Tapered	.187	4.7	.75	0.53	2.40	61.0	-	-	.750	19.1	-	-
4KM-C4L	1/4" Male BSP/ISO Tapered	1/4" Male BSP/ISO Tapered	.281	4.7	.75	0.53	2.18	55.4	1.06	26.9	.750	19.1	-	-
4L-C4L	1/4" Seal-Lok®	1/4" Seal-Lok®	.172	4.4	.66	0.52	1.82	46.2	1.03	26.2	.750	19.1	-	-
4M-C4L	1/4" Male NPT	1/4" Male NPT	.187	4.7	.75	0.53	2.18	55.4	1.04	26.4	.750	19.1	-	-
4Q-C4L	1/4" UltraSeal	1/4" UltraSeal	.180	4.6	.72	0.53	1.97	50.0	1.04	26.4	.750	19.1	-	-
4V-C4L	1/4" VacuSeal	1/4" VacuSeal	.187	4.7	.75	0.53	2.22	56.4	.98	24.9	.750	19.1	-	-
4TA-C4L	1/4" Tube Adapter	1/4" Tube Adapter	.156	4.0	.58	0.52	2.35	59.7	1.07	27.2	.750	19.1	-	-
4Z-C4L	1/4" CPI™ Compression	1/4" CPI™ Compression	.187	4.7	.75	0.53	2.42	61.5	1.03	26.2	.750	19.1	.563	14.3
6A-C4L	3/8" A-LOK® Compression	3/8" A-LOK® Compression	.187	4.7	.75	0.53	2.55	64.8	1.03	26.2	.750	19.1	.688	17.5
6Z-C4L	3/8" CPI™ Compression	3/8" CPI™ Compression	.187	4.7	.75	0.53	2.55	64.8	1.03	26.2	.750	19.1	.688	17.5
M6A-C4L	6mm A-LOK® Compression	6mm A-LOK® Compression	.187	4.7	.75	0.53	2.43	61.7	1.03	26.2	.750	19.1	.551	14.0
M6Z-C4L	6mm CPI™ Compression	6mm CPI™ Compression	.187	4.7	.75	0.53	2.43	61.7	1.03	26.2	.750	19.1	.551	14.0
4M4A-C4L	1/4" Male NPT	1/4" A-LOK® Compression	.187	4.7	.75	0.53	2.29	58.2	1.02	25.9	.750	19.1	.563	14.3
4M4F-C4L	1/4" Male NPT	1/4" Female NPT	.187	4.7	.75	0.53	2.29	58.2	1.72	43.7	.750	19.1	-	-
4M4Z-C4L	1/4" Male NPT	1/4" CPI™ Compression	.187	4.7	.75	0.53	2.29	58.2	1.02	25.9	.750	19.1	.563	14.3
4M6A-C4L	1/4" Male NPT	3/8" A-LOK® Compression	.187	4.7	.75	0.53	2.35	59.7	1.02	25.9	.750	19.1	.688	17.5
4M6Z-C4L	1/4" Male NPT	3/8" CPI™ Compression	.187	4.7	.75	0.53	2.35	59.7	1.02	25.9	.750	19.1	.688	17.5
6A-C6L	3/8" A-LOK® Compression	3/8" A-LOK® Compression	.281	7.1	2.09	0.74	3.27	83.1	1.75	44.5	1.000	25.4	.688	17.5
6F-C6L	3/8" Female NPT	3/8" Female NPT	.359	9.1	2.26	0.77	3.03	77.0	-	-	1.000	25.4	-	-
6F5-C6L	3/8" Male SAE	3/8" Male SAE	.264	6.7	2.05	0.74	2.71	68.8	1.76	44.7	1.000	25.4	-	-
6G5-C6L	3/8" Female SAE	3/8" Female SAE	.264	6.7	2.05	0.74	2.96	75.2	-	-	1.000	25.4	-	-
6KF-C6L	3/8" Female BSP/ISO Tapered	3/8" Female BSP/ISO Tapered	.359	9.1	2.26	0.77	3.03	77.0	-	-	1.000	25.4	-	-
6KM-C6L	3/8" Male BSP/ISO Tapered	3/8" Male BSP/ISO Tapered	.359	9.1	2.26	0.77	2.96	75.2	1.84	46.7	1.000	25.4	-	-
6L-C6L	3/8" Seal-Lok®	3/8" Seal-Lok®	.264	6.7	2.05	0.74	2.65	67.3	1.77	45.0	1.000	25.4	-	-
6M-C6L	3/8" Male NPT	3/8" Male NPT	.359	9.1	2.26	0.77	2.96	75.2	1.82	46.2	1.000	25.4	-	-
6Q-C6L	3/8" UltraSeal	3/8" UltraSeal	.250	6.4	2.02	0.73	2.75	69.9	1.80	45.7	1.000	25.4	-	-
6TA-C6L	3/8" Tube Adapter	3/8" Tube Adapter	.281	7.1	2.09	0.74	3.24	82.3	1.80	45.7	1.000	25.4	-	-
6Z-C6L	3/8" CPI™ Compression	3/8" CPI™ Compression	.281	7.1	2.09	0.74	3.27	83.1	1.75	44.5	1.000	25.4	.688	17.5
8A-C6L	1/2" A-LOK® Compression	1/2" A-LOK® Compression	.359	9.1	2.26	0.77	3.55	90.2	1.81	46.0	1.000	25.4	.875	22.2
8Z-C6L	1/2" CPI™ Compression	1/2" CPI™ Compression	.359	9.1	2.26	0.77	3.55	90.2	1.81	46.0	1.000	25.4	.875	22.2
M8A-C6L	8mm A-LOK® Compression	8mm A-LOK® Compression	.250	6.4	2.02	0.73	3.33	84.6	1.87	47.5	1.000	25.4	.630	16.0
M8Z-C6L	8mm CPI™ Compression	8mm CPI™ Compression	.250	6.4	2.02	0.73	3.33	84.6	1.87	47.5	1.000	25.4	.630	16.0
M10A-C6L	10mm A-LOK® Compression	10mm A-LOK® Compression	.312	7.9	2.16	0.75	3.35	85.1	1.81	46.0	1.000	25.4	.748	19.0
M10Z-C6L	10mm CPI™ Compression	10mm CPI™ Compression	.312	7.9	2.16	0.75	3.35	85.1	1.81	46.0	1.000	25.4	.748	19.0
6M6A-C6L	3/8" Male NPT	3/8" A-LOK® Compression	.281	7.1	2.09	0.74	3.09	78.5	1.76	44.7	1.000	25.4	.688	17.5
6M6F-C6L	3/8" Male NPT	3/8" Female NPT	.359	9.1	2.26	0.77	2.95	74.9	2.38	60.5	1.000	25.4	-	-
6M6Z-C6L	3/8" Male NPT	3/8" CPI™ Compression	.281	7.1	2.09	0.74	3.09	78.5	1.76	44.7	1.000	25.4	.688	17.5
6M8A-C6L	3/8" Male NPT	1/2" A-LOK® Compression	.359	9.1	2.26	0.77	3.26	82.8	1.82	46.2	1.000	25.4	.875	22.2
6M8Z-C6L	3/8" Male NPT	1/2" CPI™ Compression	.359	9.1	2.26	0.77	3.26	82.8	1.82	46.2	1.000	25.4	.875	22.2

Pressure Rating and Tubing Selection: For working pressures of A-LOK® and CPI™ tube connections, please see the [Instrument Tubing Selection Guide \(Bulletin 4200-TS\)](#), found in the Technical Section of the Parker Instrumentation Products Master Binder, or the Parker Instrument Tube Fitting Installation Manual (Bulletin 4200-B4).

For working pressures of valves with external or internal pipe threads, please see [Catalog 4260, Instrumentation Pipe Fittings](#).

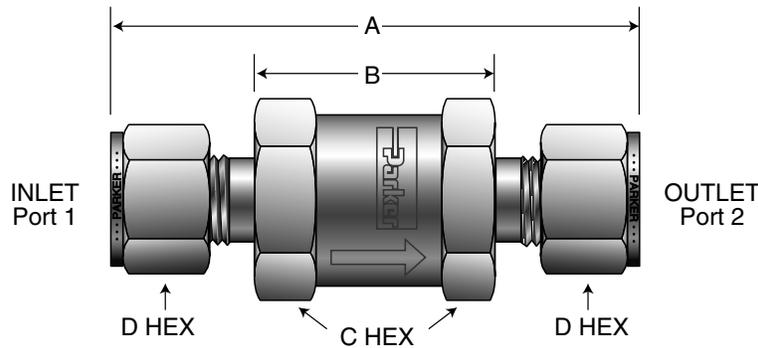

Model Shown: 4Z-C4L-1-SS

Flow Data/Dimensions (continued)

Basic Part Number	End Connections		Flow Data				Dimensions							
	(Inlet) Port 1	(Outlet) Port 2	Orifice		C_v	$x_T \ddagger$	A†		B		C		D	
			inch	mm			inch	mm	inch	mm	inch	mm		
8A-C8L	1/2" A-LOK® Compression	1/2" A-LOK® Compression	.423	10.7	3.30	0.77	4.08	103.6	2.34	59.4	1.250	31.8	.875	22.2
8F-C8L	1/2" Female NPT	1/2" Female NPT	.453	11.5	3.53	0.81	3.56	90.4	-	-	1.250	31.8	-	-
8F5-C8L	1/2" Male SAE	1/2" Male SAE	.378	9.6	2.96	0.71	3.45	87.6	2.34	59.4	1.250	31.8	-	-
8G5-C8L	1/2" Female SAE	1/2" Female SAE	.453	11.5	3.53	0.81	3.56	90.4	-	-	1.250	31.8	-	-
8KF-C8L	1/2" Female BSP/ISO Tapered	1/2" Female BSP/ISO Tapered	.453	11.5	3.53	0.81	3.56	90.4	-	-	1.250	31.8	-	-
8KM-C8L	1/2" Male BSP/ISO Tapered	1/2" Male BSP/ISO Tapered	.453	11.5	3.53	0.81	3.56	90.4	2.06	52.3	1.250	31.8	-	-
8L-C8L	1/2" Seal-Lok®	1/2" Seal-Lok®	.378	9.6	2.96	0.71	3.22	81.8	2.21	56.1	1.250	31.8	-	-
8M-C8L	1/2" Male NPT	1/2" Male NPT	.453	11.5	3.53	0.81	3.56	90.4	2.05	52.1	1.250	31.8	-	-
8Q-C8L	1/2" UltraSeal	1/2" UltraSeal	.375	9.5	2.93	0.71	3.28	83.3	2.33	59.2	1.250	31.8	-	-
8TA-C8L	1/2" Tube Adapter	1/2" Tube Adapter	.375	9.5	2.93	0.71	4.04	102.6	1.78	45.2	1.250	31.8	-	-
8V-C8L	1/2" VacuSeal	1/2" VacuSeal	.406	10.3	3.17	0.75	3.56	90.4	2.05	52.1	1.250	31.8	-	-
8Z-C8L	1/2" CPI™ Compression	1/2" CPI™ Compression	.423	10.7	3.30	0.77	4.08	103.6	2.34	59.4	1.250	31.8	.875	22.2
M12A-C8L	12mm A-LOK® Compression	12mm A-LOK® Compression	.375	9.5	2.93	0.71	4.06	103.1	2.34	59.4	1.250	31.8	.866	22.0
M12Z-C8L	12mm CPI™ Compression	12mm CPI™ Compression	.375	9.5	2.93	0.71	4.06	103.1	2.34	59.4	1.250	31.8	.866	22.0
8M8A-C8L	1/2" Male NPT	1/2" A-LOK® Compression	.423	10.7	3.30	0.77	3.82	97.0	2.19	55.6	1.250	31.8	.875	22.2
8M8F-C8L	1/2" Male NPT	1/2" Female NPT	.453	11.5	3.53	0.81	3.56	90.4	2.80	71.1	1.250	31.8	-	-
8M8Z-C8L	1/2" Male NPT	1/2" CPI™ Compression	.423	10.7	3.30	0.77	3.82	97.0	2.19	55.6	1.250	31.8	.875	22.2
12A-C12L	3/4" A-LOK® Compression	3/4" A-LOK® Compression	.594	15.1	6.01	0.38	4.34	110.2	2.60	66.0	1.375	34.9	1.125	28.6
12F-C12L	3/4" Female NPT	3/4" Female NPT	.594	15.1	6.01	0.38	4.09	103.9	-	-	1.375	34.9	-	-
12F5-C12L	3/4" Male SAE	3/4" Male SAE	.594	15.1	6.01	0.38	4.05	102.9	2.59	65.8	1.375	34.9	-	-
12G5-C12L	3/4" Female SAE	3/4" Female SAE	.594	15.1	6.01	0.38	4.09	103.9	-	-	1.375	34.9	-	-
12KF-C12L	3/4" Female BSP/ISO Tapered	3/4" Female BSP/ISO Tapered	.594	15.1	6.01	0.38	4.09	103.9	-	-	1.375	34.9	-	-
12KM-C12L	3/4" Male BSP/ISO Tapered	3/4" Male BSP/ISO Tapered	.594	15.1	6.01	0.38	4.09	103.9	2.59	65.8	1.375	34.9	-	-
12L-C12L	3/4" Seal-Lok®	3/4" Seal-Lok®	.594	15.1	6.01	0.38	3.78	96.0	2.44	62.0	1.375	34.9	-	-
12M-C12L	3/4" Male NPT	3/4" Male NPT	.594	15.1	6.01	0.38	4.09	103.9	2.58	65.5	1.375	34.9	-	-
12Q-C12L	3/4" UltraSeal	3/4" UltraSeal	.500	12.7	5.63	0.37	3.78	96.0	2.64	67.1	1.375	34.9	-	-
12TA-C12L	3/4" Tube Adapter	3/4" Tube Adapter	.594	15.1	6.01	0.38	4.24	107.7	2.18	55.4	1.375	34.9	-	-
12V-C12L	3/4" VacuSeal	3/4" VacuSeal	.594	15.1	6.01	0.38	4.64	117.9	2.64	67.1	1.375	34.9	-	-
12Z-C12L	3/4" CPI™ Compression	3/4" CPI™ Compression	.594	15.1	6.01	0.38	4.34	110.2	2.60	66.0	1.375	34.9	1.125	28.6
M20A-C12L	20mm A-LOK® Compression	20mm A-LOK® Compression	.594	15.1	6.01	0.38	4.32	109.7	2.56	65.0	1.375	34.9	1.260	32.0
M20Z-C12L	20mm CPI™ Compression	20mm CPI™ Compression	.594	15.1	6.01	0.38	4.32	109.7	2.56	65.0	1.375	34.9	1.260	32.0
M22A-C12L	22mm A-LOK® Compression	22mm A-LOK® Compression	.594	15.1	6.01	0.38	4.30	109.2	2.56	65.0	1.375	34.9	1.260	32.0
M22Z-C12L	22mm CPI™ Compression	22mm CPI™ Compression	.594	15.1	6.01	0.38	4.30	109.2	2.56	65.0	1.375	34.9	1.260	32.0
12M12A-C12L	3/4" Male NPT	3/4" A-LOK® Compression	.594	15.1	6.01	0.38	4.22	107.2	2.59	65.8	1.375	34.9	1.125	28.6
12M12F-C12L	3/4" Male NPT	3/4" Female NPT	.594	15.1	6.01	0.38	4.09	103.9	3.34	84.8	1.375	34.9	-	-
12M12Z-C12L	3/4" Male NPT	3/4" CPI™ Compression	.594	15.1	6.01	0.38	4.22	107.2	2.59	65.8	1.375	34.9	1.125	28.6
16A-C16L	1" A-LOK® Compression	1" A-LOK® Compression	.656	16.7	6.56	0.27	4.63	117.6	2.53	64.3	1.625	41.3	1.500	38.1
16F-C16L	1" Female NPT	1" Female NPT	.656	16.7	6.56	0.27	4.84	122.9	-	-	1.625	41.3	-	-
16F5-C16L	1" Male SAE	1" Male SAE	.656	16.7	6.56	0.27	4.10	104.1	2.64	67.1	1.625	41.3	-	-
16G5-C16L	1" Female SAE	1" Female SAE	.656	16.7	6.56	0.27	4.84	122.9	-	-	1.625	41.3	-	-
16KF-C16L	1" Female BSP/ISO Tapered	1" Female BSP/ISO Tapered	.656	16.7	6.56	0.27	4.84	122.9	-	-	1.625	41.3	-	-
16KM-C16L	1" Male BSP/ISO Tapered	1" Male BSP/ISO Tapered	.656	16.7	6.56	0.27	4.52	114.8	2.64	67.1	1.625	41.3	-	-
16M-C16L	1" Male NPT	1" Male NPT	.656	16.7	6.56	0.27	4.52	114.8	2.63	66.8	1.625	41.3	-	-
16L-C16L	1" Seal-Lok®	1" Seal-Lok®	.656	16.7	6.56	0.27	3.83	97.3	2.45	62.2	1.625	41.3	-	-
16TA-C16L	1" Tube Adapter	1" Tube Adapter	.656	16.7	6.56	0.27	5.11	129.8	2.52	64.0	1.625	41.3	-	-
16Z-C16L	1" CPI™ Compression	1" CPI™ Compression	.656	16.7	6.56	0.27	4.63	117.6	2.53	64.3	1.625	41.3	1.500	38.1
M25A-C16L	25mm A-LOK® Compression	25mm A-LOK® Compression	.656	16.7	6.56	0.27	4.74	120.4	2.64	67.1	1.625	41.3	1.496	38.0
M25Z-C16L	25mm CPI™ Compression	25mm CPI™ Compression	.656	16.7	6.56	0.27	4.74	120.4	2.64	67.1	1.625	41.3	1.496	38.0
16M16A-C16L	1" Male NPT	1" A-LOK® Compression	.656	16.7	6.56	0.27	4.58	116.3	2.59	65.8	1.625	41.3	1.500	38.1
16M16F-C16L	1" Male NPT	1" Female NPT	.656	16.7	6.56	0.27	4.68	118.9	3.73	94.7	1.625	41.3	-	-
16M16Z-C16L	1" Male NPT	1" CPI™ Compression	.656	16.7	6.56	0.27	4.58	116.3	2.59	65.8	1.625	41.3	1.500	38.1

†For CPI™ and A-LOK®, dimensions are measured with nuts in the finger tight position.

‡Tested in accordance with ISA S75.02. Gas flow will be choked when $P_1 - P_2 / P_1 = x_T$.

How to Order

The correct part number is easily derived from the following sequence. The six product characteristics required are coded as shown below.

***Note:** If the inlet and outlet ports are the same, eliminate the outlet port designator.

Inlet Port	Outlet Port	Body Size	Crack Pressure	Seal Material	Body Material
2A, 2F, 2F5, 2G5, 2KF, 2KM, 2M, 2TA, 2Z, M3A, M3Z	2A, 2F, 2F5, 2G5, 2KF, 2KM, 2M, 2TA, 2Z, M3A, M3Z	C2L	1/3 psi 1 psi	Blank - Fluorocarbon Rubber	B - Brass
4A, 4F, 4F5, 4G5, 4KF, 4KM, 4L, 4M, 4Q, 4TA, 4V, 4Z, M6A, M6Z	4A, 4F, 4F5, 4G5, 4KF, 4KM, 4L, 4M, 4Q, 4TA, 4V, 4Z, M6A, M6Z	C4L	5 psi 10 psi	BN - Nitrile	SS - 316 Stainless Steel
6A, 6F, 6F5, 6G5, 6KF, 6KM, 6L, 6M, 6Q, 6TA, 6Z, M8A, M8Z, M10A, M10Z	6A, 6F, 6F5, 6G5, 6KF, 6KM, 6L, 6M, 6Q, 6TA, 6Z, M8A, M8Z, M10A, M10Z	C6L	25 psi 50 psi	EPR - Ethylene Propylene Rubber	
8A, 8F, 8F5, 8G5, 8KF, 8KM, 8L, 8M, 8Q, 8TA, 8V, 8Z, M12A, M12Z	8A, 8F, 8F5, 8G5, 8KF, 8KM, 8L, 8M, 8Q, 8TA, 8V, 8Z, M12A, M12Z	C8L	75 psi 100 psi	NE - Neoprene Rubber	
12A, 12F, 12F5, 12G5, 12KF, 12KM, 12L, 12M, 12Q, 12TA, 12V, 12Z, M20A, M20Z, M22A, M22Z	12A, 12F, 12F5, 12G5, 12KF, 12KM, 12L, 12M, 12Q, 12TA, 12V, 12Z, M20A, M20Z, M22A, M22Z	C12L		*T - PTFE	
16A, 16F, 16F5, 16G5, 16KF, 16KM, 16L, 16M, 16TA, 16Z, M25A, M25Z	16A, 16F, 16F5, 16G5, 16KF, 16KM, 16L, 16M, 16TA, 16Z, M25A, M25Z	C16L		**KZ - Highly Fluorinated Fluorocarbon Rubber	

* Only available with stainless steel valves. ** Not available on C2 series.

Examples:

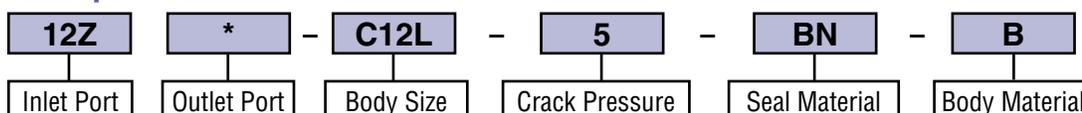

Describes a C Series Check Valve with 3/4" CPI™ compression inlet and outlet ports, a 5 psi cracking pressure, nitrile seal and brass body construction.

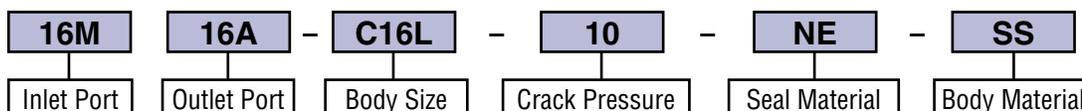

Describes an C Series Check Valve with a 1" male NPT inlet port and a 1" A-LOK® outlet port, a 10 psi cracking pressure, neoprene seal and stainless steel body construction.

Options

Oxygen Cleaning – Add the suffix **-C3** to the end of the part number to receive filters cleaned and assembled for oxygen service in accordance with Parker specification ES8003. **Example:** 4A-C4L-1-BN-SS-C3

Laser Weld – Add the suffix **-LW** to the end of the part number to receive tamper-resistant stainless steel filters. **Example:** 2F-C2L-1-SS-LW

NGV Certification – To receive valves approved and certified by CSA America, Inc, ECE R110, and ISO 15500 for use on natural gas vehicles, please contact the Instrumentation Products Division or your local authorized Parker distributor.

Available End Connections

A - Two ferrule A-LOK® compression port



M -ANSI/ASME B1.20.1 External pipe threads



TA -Tube adapter connection



L -SAE J1453, Fitting – O-ring face seal – External thread with O-ring groove designed to seal with an elastomer against a sleeve



Z -Single ferrule CPI™ compression port



Q -UltraSeal face seal port



F5 -SAE J1926/2, Part 2: Heavy-duty (S Series) stud ends



KF -British Standard BS 21 (ISO 7-1), Internal pipe threads

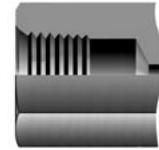

F -ANSI/ASME B1.20.1 Internal pipe threads



V -VacuSeal face seal port



G5 -SAE J1926/1, Part 1: Threaded port with O-ring seal in truncated housing

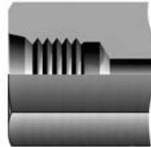

KM -British Standard BS 21 (ISO 7-1), External pipe threads



Kit Information

To order repair kits for the C Series Check Valves simply fill in the designators from the chart below.

Size	Crack Pressure	Seat Material
C2	1/3	V - Fluorocarbon
C4	1	Rubber
C6	5	BN - Nitrile
C8	10	EPR - Ethylene Propylene Rubber
C12	25	
C16	50	
	75	NE - Neoprene Rubber
	100	T - PTFE
		KZ - Highly Fluorinated Fluorocarbon

Examples: KIT-C8-10-V
KIT-C16-100-BN



Check Valve Kits Contain:
Seat
Spring
Instructions

⚠ WARNING

FAILURE, IMPROPER SELECTION OR IMPROPER USE OF THE PRODUCTS AND/OR SYSTEMS DESCRIBED HEREIN OR RELATED ITEMS CAN CAUSE DEATH, PERSONAL INJURY AND PROPERTY DAMAGE.

This document and other information from Parker Hannifin Corporation, its subsidiaries and authorized distributors provide product and/or system options for further investigation by users having technical expertise. It is important that you analyze all aspects of your application and review the information concerning the product or system in the current product catalog. Due to the variety of operating conditions and applications for these products or systems, the user, through its own analysis and testing, is solely responsible for making the final selection of the products and systems and assuring that all performance, safety and warning requirements of the application are met.

The products described herein, including without limitation, product features, specifications, designs, availability and pricing, are subject to change by Parker Hannifin Corporation and its subsidiaries at any time without notice.

Offer of Sale

The items described in this document are hereby offered for sale by Parker Hannifin Corporation, its subsidiaries or its authorized distributors. This offer and its acceptance are governed by the provisions stated in the "Offer of Sale" located in Catalog 4110-U Needle Valves (U Series).

Parker仪表管阀件联系方式：

信德迈科技(北京)有限公司 CNMEC Technology Company

地址：北京朝阳区望京街10号望京SOHO-T1-C座2115室

邮编：100102

电话：010-8428 2935, 8428 9077, 8428 3983

手机：139 1096 2635

Http：[//www.cnmec.biz](http://www.cnmec.biz)

E-mail：sales@cnmec.biz

传真：010-8428 8762

anything  Parker
Possible.™